

# **HumDigital operating instructions**

**HumSpot**

**HumCenter**

The logo for DRAABE is rendered in a bold, white, sans-serif font. Each letter is filled with white and has a thick, white outline. The letters are set against a soft, grey, rectangular glow that fades out towards the edges, giving the logo a three-dimensional, floating appearance.







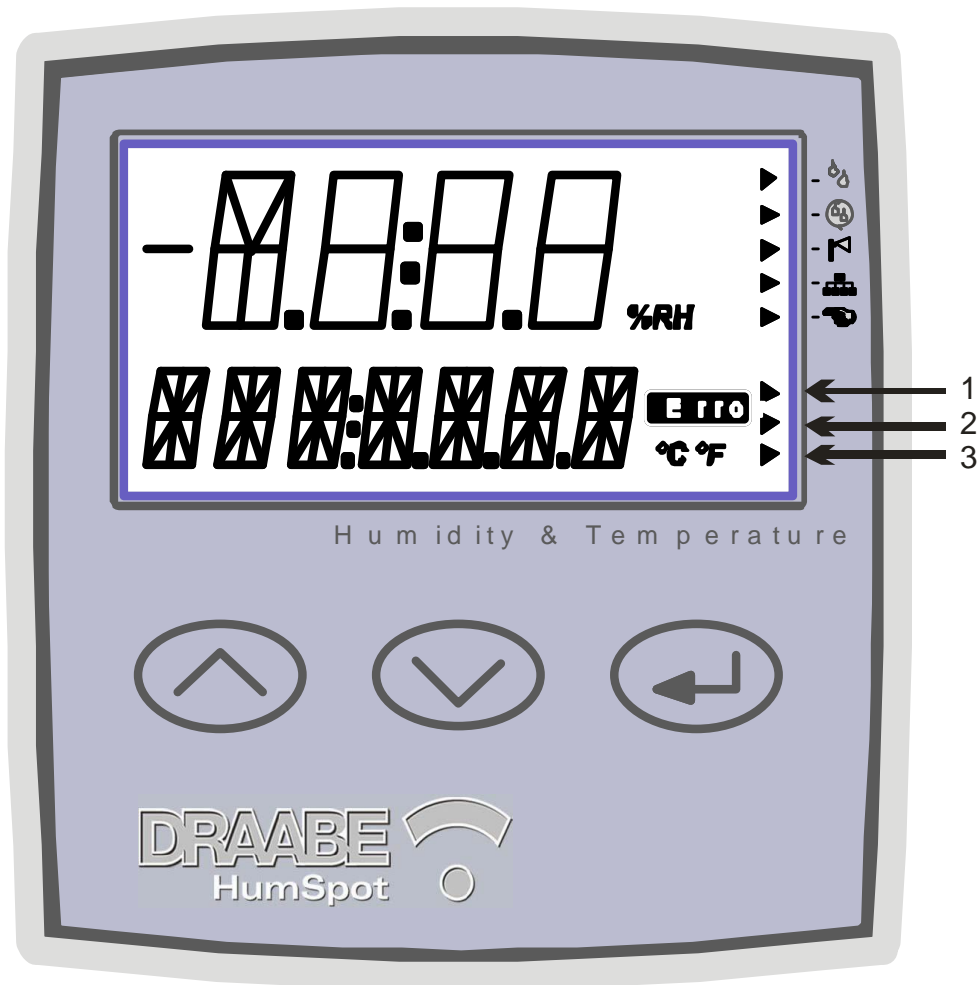

A WMH company

# Contents

<b>1</b>	<b>HumSpot .....</b>	<b>3</b>
1.1	FOG menu .....	4
1.2	DISP menu.....	5
1.3	KEYLO menu .....	6
<b>2</b>	<b>HumCenter.....</b>	<b>7</b>
2.1	Zone menu .....	7
2.1.1	Zone overview menu.....	8
2.1.2	Status menu (STAT).....	9
2.1.3	Settings menu (SETT).....	10
2.2	Water supply menu .....	11
2.2.1	Water supply overview .....	12
2.2.2	Status menu .....	13
2.3	Alarms menu .....	16
2.3.1	Pending alarms menu .....	17
2.3.2	Alarm log menu .....	17
2.4	HumCenter menu .....	18
2.4.1	HumCenter overview.....	18
2.4.2	HumCenter settings .....	19
<b>3</b>	<b>HumCenter software update .....</b>	<b>20</b>
3.1	BMS link .....	22
3.1.1	Parameters.....	22
3.1.2	Telegram .....	23
3.1.3	Transfer parameters.....	24
3.1.4	CRC checksum .....	24
<b>4</b>	<b>Troubleshooting.....</b>	<b>26</b>
4.1	HumSpot .....	26
4.2	HumCenter.....	27

# 1 HumSpot



Symbol	Function	Description
	Humidification request	The internal hygrostat function or the external hygrostat is requesting humidification
	AFWS request	The automatic fresh water system is requesting humidification
	Atomiser active	The solenoid valves for the atomiser are open.
	BUS active	HumiPur is being addressed via the BUS. i.e. there is a connection to CenterPur.
	Manual operation	The hygrostat has been manually overridden. If "□ ↔ → ↑ ↓ →" is set to "no", this symbol will flash
1 – 3	Mean value	Shows mean value of calculation across 16, 60 and 180 min
	Function keys	Select menu points and enter values
	Function keys	Call up menu points and enter values
	Enter key	Call up menu and confirm values.

The menu mode can be called up using the enter key. The separate menu points can be called up with the arrow keys. Each menu has an "EXIT" point to return to the next higher menu.

If the key lock is enabled, the code must be entered first to access the menu.

The entire menu level is shown in the illustration below. In the following, the separate menus will be described in greater detail.

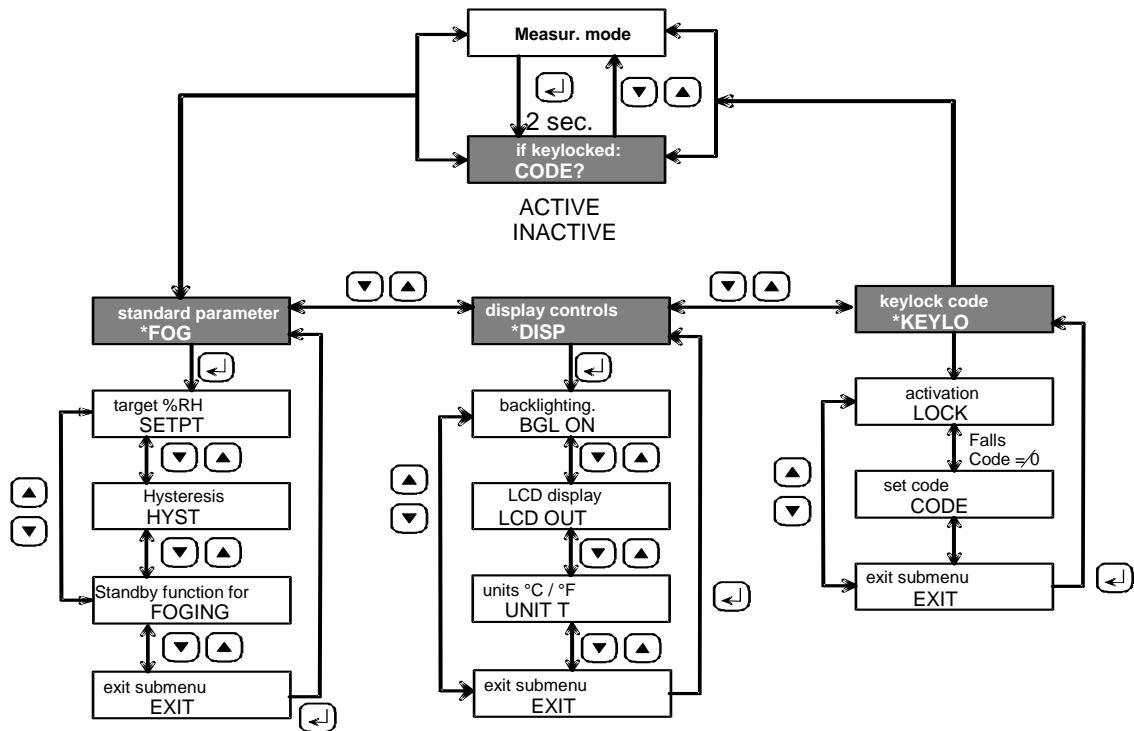

### 1.1 FOG menu

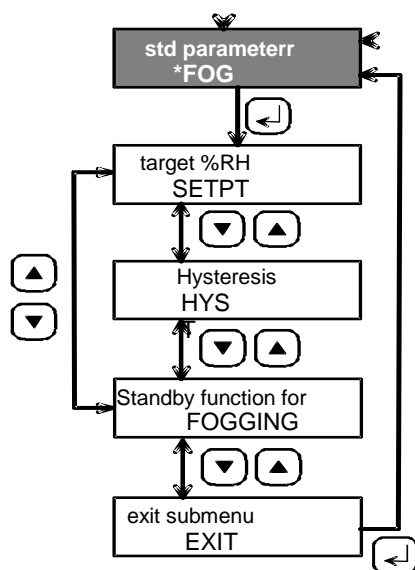

In the FOG menu, the following settings can be made:

Menu	Parameter	Range
FOG	Humidity target	10 – 90 % RH Steps of 1%, default: 50%
FOG	Hysteresis	0.5 – 10.0% RH Steps of 0.1% RH Default 2% RH
FOG	Fogging	Auto, no Default: "Auto"

## 1.2 DISP menu

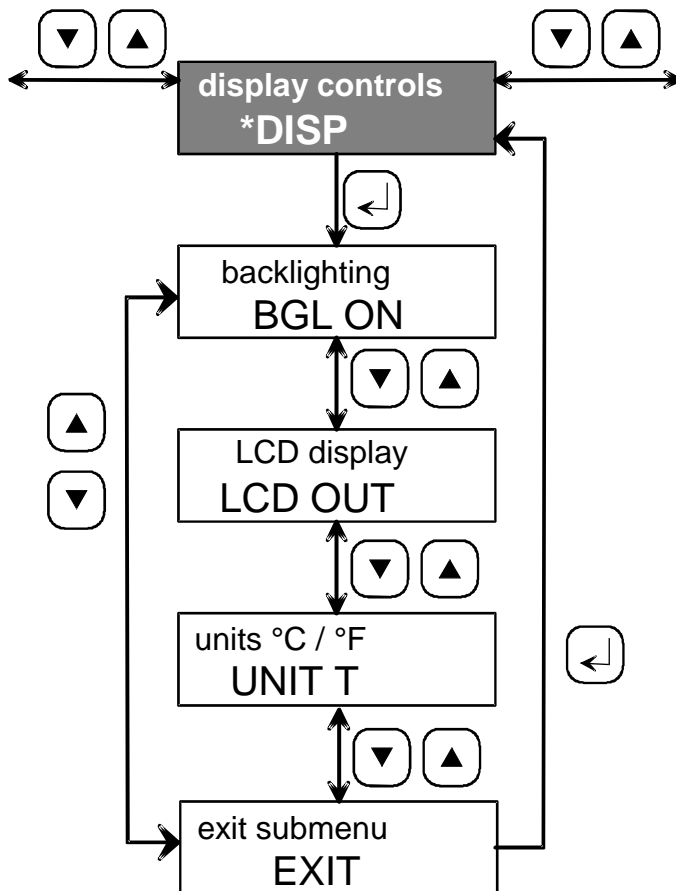

Menu	Parameter	Range
DISP	Backlighting (BGL)	00:05 – 10:00 [mm:ss] Steps of 1 s Default: 1 min
DISP	LCD display	Auto, On Default: Auto
DISP	Temperature unit	°C, °F Default: °C

### 1.3 KEYLO menu

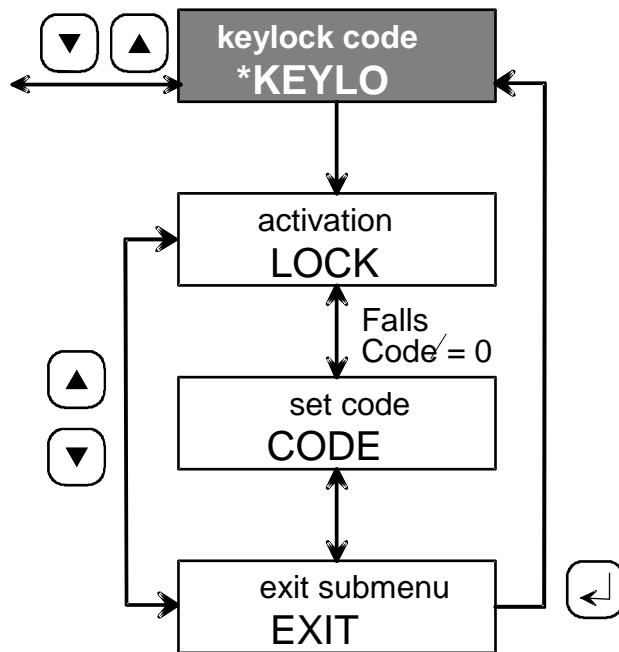

Menu	Parameter	Range
KEYLO	Code	0000 – 9999 Default: 0000
KEYLO	Activate code	

## 2 HumCenter

The HumCenter has several function keys and a display. The separate function keys are explained below.

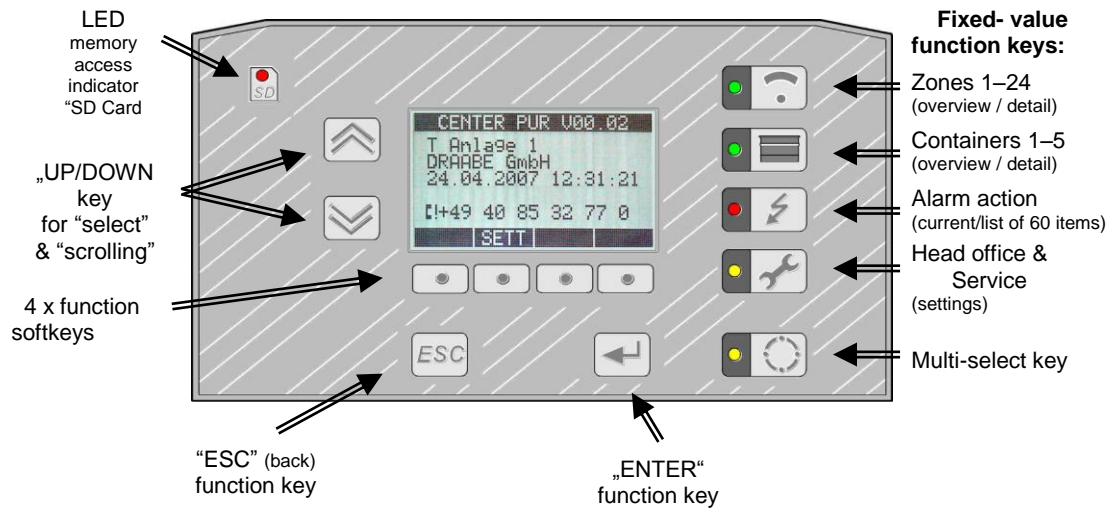

### 2.1 Zone menu

The zone overview is displayed by pressing the "Zone" function key. The display shows the first five zones. For every zone, the display indicates the zone number, the current relative humidity and temperature and a simplified status report. Select a zone or see more zones using the "UP"/"DOWN" keys.

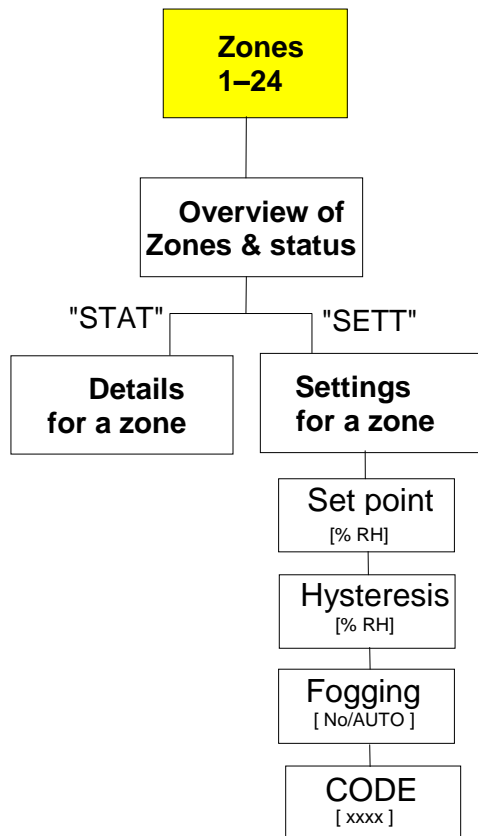

### 2.1.1 Zone overview menu

```

## %RH °C Status
00 50.0 24.8 Stdby
01 0.0 0.0 ON
02 0.0 0.0 FWA
03 0.0 0.0 ON
04 0.0 0.0 Stdby
...
STAT SETT MAINT
  
```

Simplified status		
Display	Priority*	Description
ERR	1	Error
ON	2	Humidification or request active
AFWS	3	Automatic fresh water system active
OFF	4	Fogging = No
Stby	5	Humidification off, no request

\* When two status reports occur at once, that with lower priority is shown.



The advanced status display (STAT) or the settings (SETT) for the selected zone can be selected using the softkeys below the display.

### 2.1.2 Status menu (STAT)

The status menu shows the status in detail. As well as the relative humidity, temperature and the status there is also additional information on the zone. This shows whether the zone is ready for operation (zone ready) or which problem has occurred in case of malfunction.

```

STATUS ZONE #00
Hum:    50.0%RH
Temp:   25.0 °C
Stat:   Stdby
Info:   Zone ready

```

Parameter		
Name	Function	Notes
Hum:	Current humidity [% RH], sensor resolution 0.1 % RH	
Temp:	current temperature [°C] or [°F], resolution 0.1 °C	
Stat:	Summary of status	
Info:	Additional status information	

Status		
Display	Priority*	Description
ERR	1	Error
Hand	2	Manual operation on
Humid	3	Humidification active
FWA	4	AFWS active
H req	5	Humidification request
AFWS req	6	AFWS request
Stdby	7	Standby (e.g. target value reached)

\* When two status reports occur at once, that with lower priority is shown.

Info		
Display	Priority*	Description
Com err	1	Communication error with HumiPur
Cap err	2	Capability error: HumiPur cannot fulfil the function required. Causes: Firmware not updated, device technology outdated
no HPS	3	No HPS entered.
Sens err	4	Communication with sensor disturbed (e.g. sensor malfunction)
Max err	5	Maximum hygrostat released
HPS err	6	HPS not released (timeout)
Unkn err	7	Unknown error
Zone Ready	8	Zone ready for operation

\* When two status reports occur at once, that with lower priority is shown.

Return to the overview using the ESC key.

### 2.1.3 Settings menu (SETT)

The settings menu shows the following settings for the selected zone:

```
SETTINGS ZONE #00
SETPT: 50%RH
HYST: 0.0%RH
FOGGING: No
CODE: 0000

SET
```

Parameter		
Name	Function	Notes
SETPT:	Humidity target [% RH]	10 – 90 % RH Steps of 1%, Default: 50%
HYST:	Hysteresis [% RH]	0.5 – 10.0% RH Steps of 0.1% RH Default 2% RH
FOGGING:	Fogging parameters	Auto, no Default: "Auto"
CODE:	Keylock code	0000 – 9999 Default: 0000

Select and change the settings using the UP/DOWN keys. After selection, then click on the “SET” softkey to change the value.

Move the cursor with the arrow keys and set the value with the + and - keys. Use the ENTER key to confirm and save the new value. Undo the change with the ESC key.

```
SETTINGS ZONE #00
SETPT: 50%RH
HYST: 0.0%RH
FOGGING: No
CODE: 0000

+ - + -
```

## 2.2 Water supply menu

Press the “water supply” function key to display an overview of the units attached to the HumCenter and their current status.

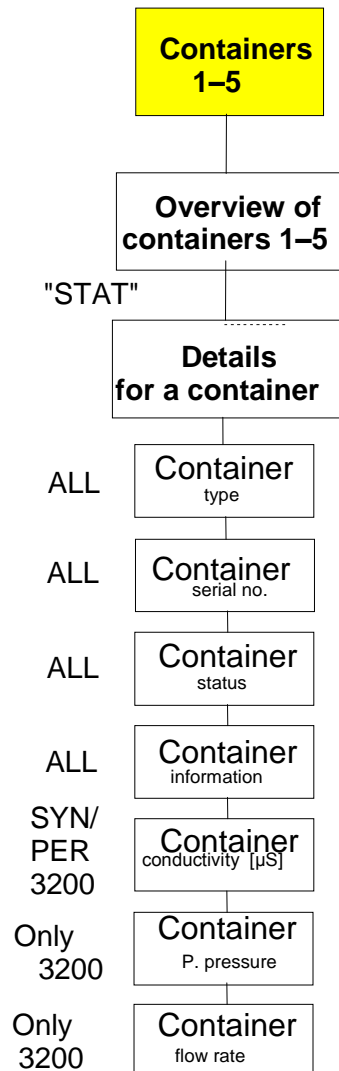

## 2.2.1 Water supply overview

#	TYPE	STATUS
1	HIG	ON
2	HIG	Stby
3	SYN	ERR
4	PER	ON
STAT		MAINT

Simplified status for CSF 3121 (PER)		
Display	Priority*	Description
ERR	1	Error
FULL	2	Tank full
ON	3	In operation
* When two status reports occur at once, that with lower priority is shown.		

Simplified status for CSF 3200 (PER)		
Display	Priority*	Description
ERR	1	Error
FULL	2	Tank full
ON	3	In operation
* When two status reports occur at once, that with lower priority is shown.		

Simplified status for LS 3400 (SYN)		
Display	Priority*	Description
ERR	1	Error
Mntc	2	Maintenance
FWA	3	Circulation
ON	4	In operation
* When two status reports occur at once, that with lower priority is shown.		

Simplified status for HPS 3200 (HIG)		
Display	Priority*	Description
ERR	1	Error
ON	2	Pump running
Stby	3	No malfunction, pump off
* When two status reports occur at once, that with lower priority is shown.		

## 2.2.2 Status menu

Select a unit with the UP/DOWN keys and display the detailed status with the "STAT" softkey.

```
## STATUS HIG #1
Dtype: HPS3200
DNum: 4294967296
Stat: ON
Info: HighPur ready
████████████████
```

Parameters for CSF3121 (PER)		
Name	Function	Notes
Dtype:	Device type	CSF3121 (M261, M262, M263, D250)
DNum:	Device number	(D250, D251)
Stat:	Summary of status	See table below
Info:	Additional status information	See table below

Status of CSF3121 (PER)		
Display	Priority*	Description
ERR	1	Error (M201, M236, M250, M251), com error
Full	2	Tank full (M235)
ON	3	In operation

\* When two status reports occur at once, that with lower priority is shown.

Info on CSF3121 (PER)		
Display	Priority*	Description
Com err	1	Communication error
Cap err	2	Capability error: CSF cannot fulfil the function required. Causes: Firmware not updated, device technology outdated
Safety press. err	3	Safety pressure error (M201)
Inlet press. err	5	Inlet pressure error (M236)
Conductivity err	6	Conductivity error (M250)
Motor prot. err	4	Motor protection error (M251)
PerPur ready	7	PER ready for operation

\* When two status reports occur at once, that with lower priority is shown.

Parameters for CSF3200 (PER)		
Name	Function	Notes
Dtype:	Device type	CSF3200 (M261,M262, M263, D250)
DNum:	Device number	(D251,D252)
Con:	Conductivity	µS (D240)
Press:	Pump pressure	bar (D239)
Flow rate:	Flow rate	L/h (D238)
Stat:	Summary of status	See table below
Info:	Additional status information	See table below

Status of CSF3200 (PER)		
Display	Priority*	Description
ERR	1	Error (M200, M201, M204, M236, M237, M253), com error
Full	2	Tank full (M239)
ON	3	In operation

\* When two status reports occur at once, that with lower priority is shown.

Info on CSF3200 (PER)		
Display	Priority*	Description
Com err	1	Communication error
Cap err M	2	Capability error: CenterPur cannot fulfil the function required. Causes: Firmware not updated, device technology outdated
Cap err D	3	Capability error: PER cannot fulfil the function required. Causes: Firmware not updated, device technology outdated
Safety press. err	7	Safety pressure error (M201)
Inlet press. err	8	Inlet pressure error (M200)
Conductivity err	3	Conductivity error (M236)
Motor prot. err	6	Motor protection error (M253)
Pump press. err	5	Pump pressure error (M237)
Mntc pump	9	Pump maintenance (M204)
PerPur ready	10	PER ready for operation

\* When two status reports occur at once, that with lower priority is shown.

Parameters for LS3400 (SYN)		
Name	Function	Notes
Dtype:	Device type	LS3400 (M261,M262, M263, D250)
DNum:	Device number	(D251,D252)
Con:	Conductivity	µS (D248)
Stat:	Summary of status	See table below
Info:	Additional status information	See table below

Status for LS3400 (SYN)		
Display	Priority*	Description
ERR	1	Error (M200–M205), com error
Mntc	2	Maintenance (M234)
FWA	3	Circulation (M235)
ON	4	In operation
* When two status reports occur at once, that with lower priority is shown.		

Info on LS3400 (SYN)		
Display	Priority*	Description
Com err	1	Communication error
Cap err M	2	Capability error: CenterPur cannot fulfil the function required. Causes: Firmware not updated, device technology outdated
Cap err D	3	Capability error: LS cannot fulfil the function required. Causes: Firmware not updated, device technology outdated
Safety press. err	7	Safety pressure error (M200)
Inlet press. err	9	Inlet pressure error (M201)
Gas press. err	8	Gas pressure error (M202)
Motor prot. err	6	Motor protection error (M203)
Synthesis err	5	Synthesis error (M204)
Product err	4	Product error (M205)
Mntc Syn	10	Maintenance (M234)
SynPur ready	11	PER ready for operation
* When two status reports occur at once, that with lower priority is shown.		

Parameters for HPS 3200 (HIG)		
Name	Function	Notes
Dtype:	Device type	HPS3200 (M261, M262, M263, D250)
DNum:	Device number	(D250, D251)
Stat:	Summary of status	See table below
Info:	Additional status information	See table below

Status for HPS 3200 (HIG)		
Display	Priority*	Description
ERR	1	Error (M200–M204), com error
ON	2	Pump running (M232)
Stdby	3	No malfunction, pump off
* When two status reports occur at once, that with lower priority is shown.		

Info for HPS 3200 (HIG)		
Display	Priorit y*	Description
Com err	1	Communication error
Cap err M	2	Capability error: CenterPur cannot fulfil the function required. Causes: Firmware not updated, device technology outdated
Cap err D	3	Capability error: HIG cannot fulfil the function required. Causes: Firmware not updated, device technology outdated
Motor prot. err	6	Motor protection switch (M204)
Leakage err	4	Leakage error (M201)
Min. press. err	5	Minimum pressure error (M200)
Inlet press. err	8	Inlet pressure error (M202)
Temp. err	7	Temperature error (M203)
HighPur ready	9	Container ready for operation

\* When two status reports occur at once, that with lower priority is shown.

### 2.3 Alarms menu

Press the "Alarms" function key to display the "Alarms" overview menu. In this menu you can switch between the two menu levels "Pending" and "Log".

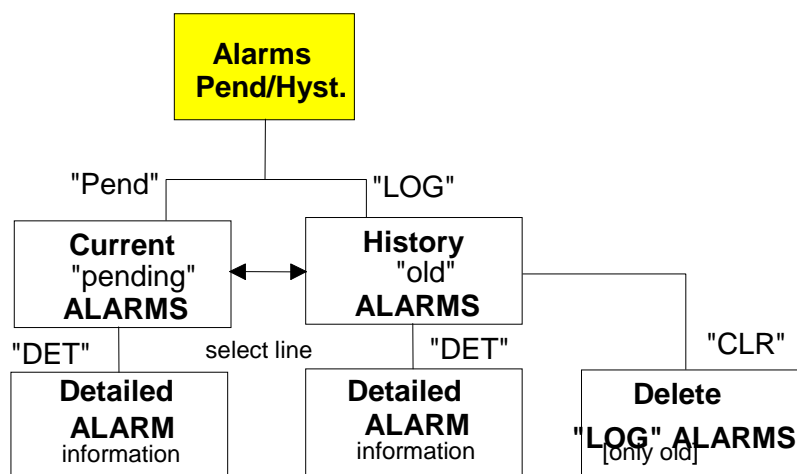



### 2.3.1 Pending alarms menu

In the "Pending" menu, all current pending alarm reports are shown. For further details

```
PENDING ALARMS
▶ZON00 09.01.07 10:30
▶ZON01 09.01.07 10:28
▶ZON11 09.01.07 10:33
▶ZON13 09.01.07 10:34
```

```
LOG
```

### 2.3.2 Alarm log menu

In the "Log" menu, all past alarm reports are shown.

```
ALARM LOG
▶ZON13 09.01.07 10:34
▶ZON14 09.01.07 10:47
ZON10 09.01.07 10:47
ZON14 09.01.07 10:49
ZON12 09.01.07 10:49
DET | PEND | CLR
```

## 2.4 HumCenter menu

Press the “HumCenter” function key to display the HumCenter overview menu.

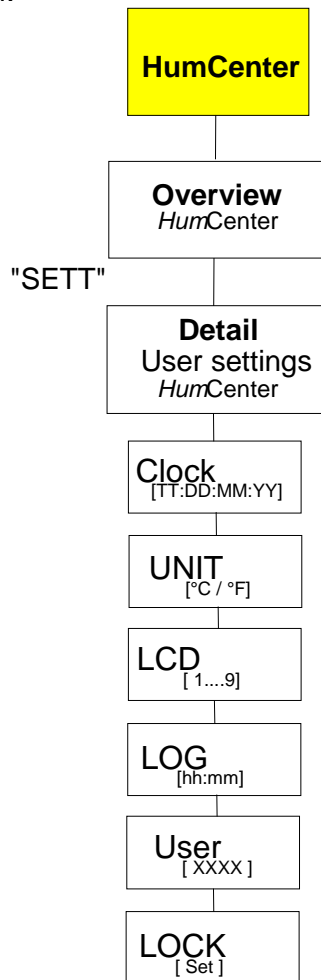

### 2.4.1 HumCenter overview

```

CENTER PUR V00.00
Test Anlage 1
Daniel Schnyder
03.01.2007 16:35

0055 416 65 25
  
```

Parameter		
Line	Parameter	Notes
1	VXX.XX	Version of the CenterPur software
2	Installation:	Display of unit
3	Operator:	Name of customer
4	Date & time:	Current time
6:	Service phone:	Number in case of malfunction

Further settings can be made using the “SETT” softkey.

## 2.4.2 HumCenter settings

```

SETTINGS CENTERPUR
Clock setting...
Unit temperature: °C
LCD contrast: 0
Log int: 10:00h
Code: ****
...
SET

```

Parameter		
Name	Function	Notes
Clock setting...	Submenu to set the clock	
Unit temperature:	Temperature unit (only CenterPur)	°C or °F
LCD contrast:	Display contrast	
LOG Int:	Interval for logger [hh:mm]	Interval for data logger
Load Configuration	Load configurations from SD card	
Save Configuration	Save configurations on SD card	
Reboot System	Reboot HumCenter	
Code:	CenterPur code	
Lock...:	Activate code immediately	

### 3 HumCenter software update

The HumCenter software can be updated very simply using the SD card. The current software is sent by e-mail, copied onto the SD card and then installed on the HumCenter.

Carry out the following steps:

1. Remove the SD card from the HumCenter and connect it to a computer.



2. Enclosed in the e-mail are the files "boot.sys" and "flash.bin".

Datei	Datum	Zeit	Größe
Flash.bin	26.09.2007	10:09:00	190 KB
Boot.sys	30.08.2007	15:43:38	36 KB

3. Copy these files and save them on the SD card.

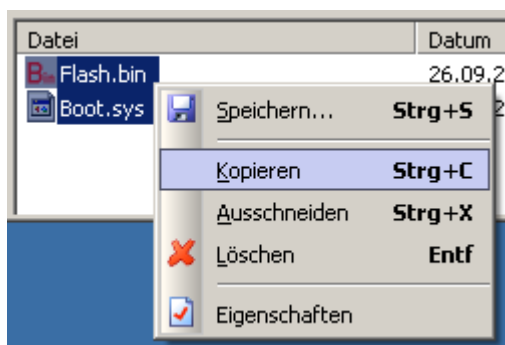

4. Re-insert the SD card in the HumCenter.



5. Select the "HumCenter" menu.

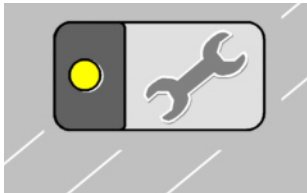

6. Press the "SETT" key and select "Reboot system".

```
HumCenter V1.06
Save Configuration
Load Configuration
Reboot System      mmm
Code: ****
[SETT]
```

7. Confirm the request with "yes" and keep the "HumCenter" key pressed during the reboot until "Flash Programmer" appears in the display. The new software is now automatically updated.

After the installation, restart the HumCenter. All previous settings are retained.

### 3.1 BMS link

The HumCenter has an interface to link to the building services management system. The HumCenter is designed so that the parameters to be transferred are converted to the bus system using an external converter (e.g. RS232 Ethernet converter).

The converter is connected at the RS232 interface on the top of the HumCenter next to the SD card slot. The maximum cable length between the HumCenter and the converter is 3m.

#### 3.1.1 Parameters

The following parameters are transferred:

- Date/time
- Zone alarms
- Container alarms
- Current zone values (humidity, temperature)

Each parameter is labelled in the telegram using identifiers:

Identifier	Parameter	Format	BACnet Option Objects	Notes
<b>A</b>	Date/time	U8;U8;U16;U8;U8;U8 (DD;MM;YYYY;HH;MM;SS)  Example: A07;11;2007;11;45;15	AI 201	Time telegram sent
<b>B</b>	Zone alarms	U32 Bit0=Zone1, Bit1=Zone2 etc.  Examples: B0 = no alarm B1 = zone 1 alarm B3 = zone 1 and zone 2 alarm	BI 1-24 Objects are true if faulted. Example if BI... 1=1 Zone 1 fault 4=0 Zone 4 ok 7=1 Zone 7 fault	
<b>C</b>	Container alarms	U8 Bit0=Container1 etc.  Examples: C0 = no alarm C1 = container 1 alarm	BI 101-105 Objects are true if faulted. Example if BI... 101=1 Ctn 1 fault 104=0 Ctn 4 ok 105=1 Ctn 5 fault	
<b>D</b>	Current zone values	Float, Float (HH.H;TT.T)  Example: D1:39.5;23.8	AI 1-24 Humidity AI 101-124 Temp AI 1=39.5 is 39.5%rh AI 101=23.8 is 23.8°C	HH.H in [%RH] TT.T in [°C]
<b>Z</b>	CRC	U16		

The parameters transferred can only be read; it is not possible to change the settings via the BMS.

### 3.1.2 Telegram

Every five seconds, the HumCenter sends a telegram with the parameters described above. The following is an explanation of the symbols used in the telegram and the telegram layout, using an example.

The following symbols are used in the telegram:

Symbol	Description	Notes
*	Start symbol	Start of telegram
A – Z	Identifier	Identifies the parameter
:	Index	Index in case of array data (D:1)
;	Data separator	Separates the data (D:1; 25.0; 50.0 – “;” separates the data from the index and the temperature from the humidity)
.	Decimal point	
CR+LF	End of line	Lines of telegram finish with a “carriage return” and “line feed”.

Layout of a sample telegram with the following configuration:

- 3 zones (HumSpots)
- 2 containers

Telegram:

```
*A07;11;2007;11;29;04;B0C2D:1;43.3;24.8;D:2;42.5;23.3;D3:40.8;20.1Z32219
```

The telegram contains the following information:

- **Date/time:** 07.11.2007, 11:29:04 (A07;11;2007;11;29;04)
- **Zone alarms:** No alarm (B0)
- **Container alarms:** Container 2 alarm (C2)
- **Zone 1 values:** Humidity: 43.3 % rH, temp.: 24.8 °C (D:1;43.3;24.8)
- **Zone 2 values:** Humidity: 42.5 % rH, temp.: 23.3 °C (D:1;42.5;23.3)

- **Zone 3 values:** Humidity: 40.8 % rH, temp.: 20.1 °C  
(D:1;40.8;20.1)
- **Checksum:** 32219 (Z32219)

### 3.1.3 Transfer parameters

- 19,200 bit/s
- Data bits: 8
- Stop bit: 1
- Parity: none
- Flow control: none

### 3.1.4 CRC checksum

It is not usually necessary to calculate and evaluate the checksum.

If desired, it can be calculated as follows:

Up to and including the “Z” identifier, the function “`crc_one_byte()`” is accessed for every figure in the telegram, with “`*oldchecksum`” initialised to 0 at the start of the telegram.

#### Algorithm

```

/* calculate 16-Bit CRC */
/* At start of calculation *oldchecksumP must be */
/* initialised to 0 */
/* oldchecksumP (IO): pointer on (previous) checksum*/
/* b: next byte of data stream */
void crc_one_byte(u16 *oldchecksumP, unsigned char b)
{
    u16 result;
    unsigned char a=b ^ (*oldchecksumP)>>8 ^ (*oldchecksumP)>>4 ^ (*oldchecksumP)>>1
    ^ (*oldchecksumP)<<1;
    result = (*oldchecksumP)<<8 | a ^ a>>7;
    *oldchecksumP = result;
}

```



### 3.1.5 BACnet Option connection

The BACnet Gateway is a small device that attaches to the HumCenter's serial communication port. This is done by connecting the two with a serial cable with a DB9 female to DB9 male connection. This is a straight cable, pin 1 to 1, 2 to 2 ... 9 to 9. The Gateway is then connected to the BACnet network with an Ethernet Cable. It must also be supplied with power (120V/1P)

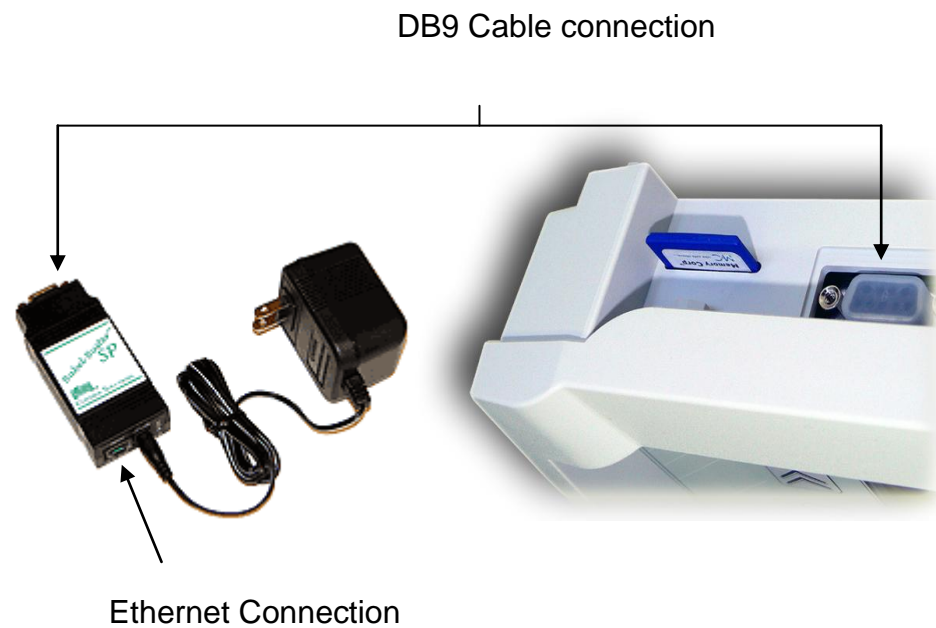

#### **BACnet Gateway general specification:**

- Powered by 9 to 30VDC @ 0.37A to 0.11A
- 120VAC power supply included (12VDC output)
- FCC Class A, CE Mark
- Operating temperature -40°C to +85°C; Humidity 5% to 90%

## 4 Troubleshooting

### 4.1 HumSpot

<b>Error message</b>	<b>Possible causes</b>	<b>Possible solutions</b>
BUS ERR	<ol style="list-style-type: none"><li>1. The HumCenter is switched off.</li><li>2. Bus communication error (wiring error) between HumSpot and HumCenter</li><li>3. No bus ID or wrong bus ID entered in HumSpot.</li><li>4. Bus ID assigned to a unit without HumCenter.</li></ol>	<ol style="list-style-type: none"><li>1. Check the electricity supply to the HumCenter.</li><li>2. Check the bus connection at HumSpot and HumCenter.</li><li>3. Check the bus ID at HumSpot.</li><li>4. Set the bus ID to 0.</li></ol>
CAP ERR	<ol style="list-style-type: none"><li>1. Capability error: HumSpot does not have current firmware.</li><li>2.</li></ol>	<ol style="list-style-type: none"><li>1. Install the current firmware in the HumSpot.</li><li>2.</li></ol>
No HPS	<ol style="list-style-type: none"><li>1. No HPS has been assigned to the HumSpot</li><li>2.</li></ol>	<ol style="list-style-type: none"><li>1. Assign an HPS to the HumSpot using the HumCenter.</li><li>2.</li></ol>
SENS ERR	<ol style="list-style-type: none"><li>1. Hygrostat malfunction.</li></ol>	<ol style="list-style-type: none"><li>1. Replace the sensor.</li></ol>
MAX ERR	<ol style="list-style-type: none"><li>1. Maximum hygrostat has triggered due to high room humidity.</li><li>2.</li></ol>	<ol style="list-style-type: none"><li>1. Check maximum hygrostat is functioning.</li><li>2. Check hygrostat is functioning.</li><li>3. Adjust target value of maximum hygrostat.</li></ol>
HPS ERR	<ol style="list-style-type: none"><li>1. No release received from HPS (timeout).</li></ol>	<ol style="list-style-type: none"><li>1. Check if the HPS is malfunctioning.</li><li>2. Check the wiring between the HumSpot and HPS.</li></ol>

## 4.2 HumCenter

Zone:

Error message	Possible causes	Possible solutions
COM ERR (Zone)	<ol style="list-style-type: none"> <li>1. The HumSpot is switched off.</li> <li>2. Bus communication error (wiring error) between HumSpot and HumCenter</li> <li>3. No bus ID or wrong bus ID entered in HumSpot.</li> <li>4. Bus ID assigned to a unit without HumCenter.</li> </ol>	<ol style="list-style-type: none"> <li>1. Check the electricity supply to the HumSpot.</li> <li>2. Check the bus connection at HumSpot and HumCenter.</li> <li>3. Check the bus ID at HumSpot.</li> <li>4. Set the bus ID to 0.</li> </ol>
No HPS	<ol style="list-style-type: none"> <li>1. No HPS has been assigned to the HumSpot</li> </ol>	<ol style="list-style-type: none"> <li>1. Assign an HPS to the HumSpot using the HumCenter.</li> </ol>
SENS ERR	<ol style="list-style-type: none"> <li>1. Hygrostat malfunction.</li> </ol>	<ol style="list-style-type: none"> <li>1. Replace the sensor.</li> </ol>
MAX ERR	<ol style="list-style-type: none"> <li>1. Maximum hygrostat alert has set off due to high room humidity.</li> <li>2.</li> </ol>	<ol style="list-style-type: none"> <li>1. Check maximum hygrostat is functioning.</li> <li>2. Check hygrostat is functioning.</li> <li>3. Adjust target value of maximum hygrostat.</li> </ol>
HPS ERR	<ol style="list-style-type: none"> <li>1. No release received from HPS (timeout).</li> </ol>	<ol style="list-style-type: none"> <li>1. Check if the HPS is malfunctioning.</li> <li>2. Check the wiring between the HumSpot and HPS.</li> </ol>

Water supply

Error message	Possible causes	Possible solutions
COM ERR (Water Supply)	<ol style="list-style-type: none"> <li>1. Unit is switched off.</li> <li>2. Bus communication error (wiring error) between unit and HumCenter</li> </ol>	<ol style="list-style-type: none"> <li>1. Check the electricity supply to the unit.</li> <li>2. Check the bus connection at the unit and the HumCenter.</li> </ol>
CAP ERR M	<ol style="list-style-type: none"> <li>1. Capability error: The HumCenter does not have current firmware.</li> </ol>	<ol style="list-style-type: none"> <li>1. Install the current firmware in the HumCenter.</li> </ol>

**Manufacturer:**

DRAABE Industrietechnik GmbH

Schnackenburgallee 18

D-22525 Hamburg

+49 40 853277-0

[www.DRAABE.de](http://www.DRAABE.de)

A WMH company

**Distributor:**

Nortec Systems Inc.

1860 Renaissance Blvd.

Sturtevant, WI 53177

262.884.4669

[www.nortecsystems.us](http://www.nortecsystems.us)