

# On/Off Digital Wall Humidistat Installation Instructions

This document covers the operation and installation instructions for the following digital humidistat:

**Part #:** 2548731

**Description:** ON/OFF Wall Humidistat

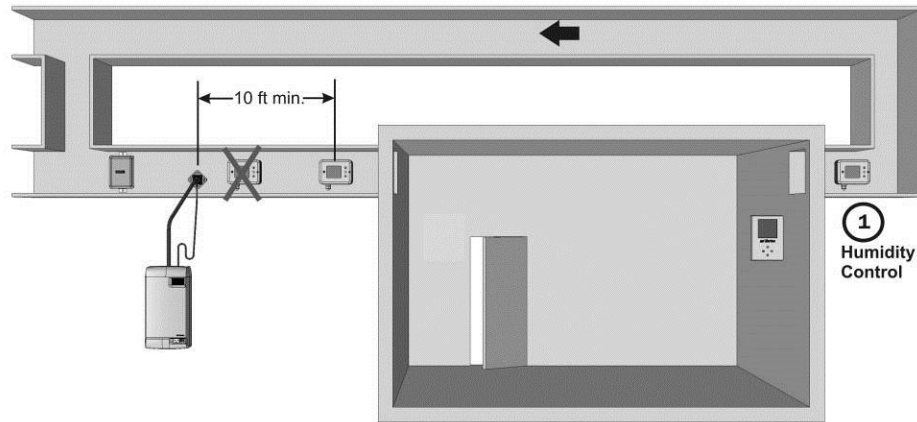

**Figure 1: Wall Humidistat Installation Locations**

## 1 - Wall Humidity Control Installation

### Location:

- 1 Do not install humidistat on an outside wall, near a heat source and/or in direct sunlight.
- 2 Install the humidistat on a surface that is flat and clean.
- 3 Install a vapor barrier to prevent sensor from interacting with inner wall draft.
- 4 Use a sealed, single gang electrical mounting box (recessed in the wall) to mount the humidity sensor.

### Installation:

- 1 Pull cables 6" (15 cm) out of the wall.
- 2 Remove front face with digital display by loosening plastic retaining screw at the bottom. The front face will unhinge from the top of the retaining clips.
- 3 Connect the control wires to the terminals according to wiring diagram 2548733 in this document. Figure 2 outlines the terminal layout.
- 4 Secure the metal bracket to the mounting electrical box using 2 screws (#6 x 3/4" Phillips). Make sure the heads do not stand out more than 1/5" (5 mm) from mounting surface.
- 5 Remount front face on metal bracket. Ensure clips engage the grooves on top of the bracket. Gently tighten bottom plastic retaining screw.

### Configuration:

- 1 Using keypad, set specified humidity. For general health and comfort, a humidity setting of 50% is recommended.
- 2 See Table 3 for outdoor temperature setback configuration, if optional outdoor temperature sensor is supplied (P/N 2520263 or 2553858).

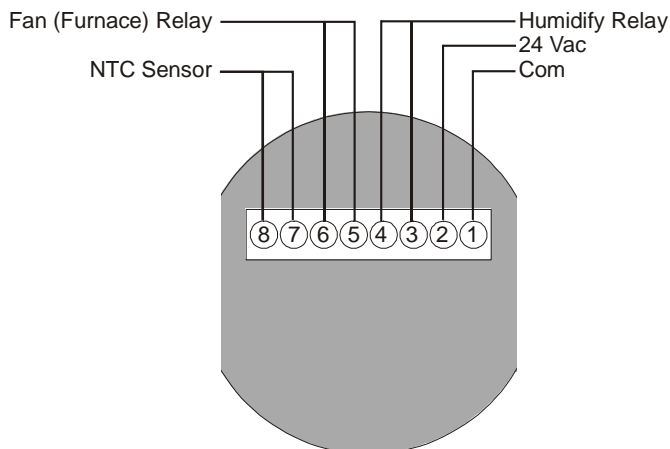
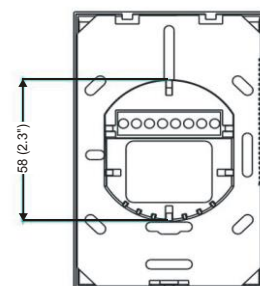
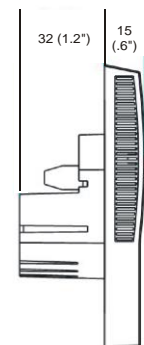
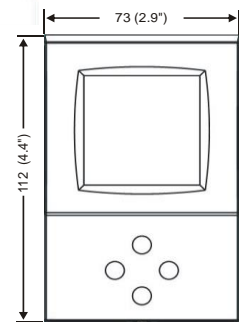

**Figure 2: Terminal Strip**

**Figure 3: Dimensions**

## Duct Humidstat LCD Display

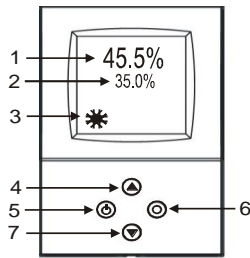

### Legend:

- 1 Display of current humidity value.
- 2 Display of setpoint.
- 3 Snowflake displayed if outdoor temperature setback active.
- 4 Adjusts setpoint and calibration (up).
- 5 Power ON/OFF.
- 6 Toggles between RH setpoint and temperature (if temperature sensor present).
- 7 Adjusts setpoint and calibration (down).

### Sensor Calibration

The humidity sensor is factory calibrated, however, it can be field recalibrated. The calibration routine can be accessed by pressing the option key for > 3 seconds. Option key = the right key on the wall mount and middle key on the right side of the duct mount. Once the display changes select CAL H, press OPTION key again - the offset value is now shown.

Press up down keys to change. Press option key again to save changed value and return to previous level.

### Login Procedure

Most applications can use default values.

User Parameters (Password 0009)

- 1 Press UP and DOWN button simultaneously for three seconds. The display shows the software version in the large digits and the product code in the small digits.
- 2 Pressing the OPTION button will indicate CODE on the small digits and 0000 on the large digits.
- 3 The code for accessing the control parameters is 0009
- 4 Select this using UP or DOWN buttons.
- 5 Press OPTION button after selecting the correct code.
- 6 Once logged in, the parameter is displayed immediately.
- 7 Select the parameters with the UP/DOWN buttons. Change a parameter by pressing the OPTION button. Three triangles will show up on the lower right and indicate that the parameter may be modified now. Use UP or DOWN buttons to adjust the value.
- 8 After you are done, press OPTION or POWER in order to return to the parameter selection level.

**Table 1: User Parameters**

Parameter	Description	Range	Default
UP 00	Enable change of operation modes	ON, OFF	ON (Enabled)
UP 01	Enable change of setpoints	ON, OFF	ON (Enabled)
UP 02	State after power failure: 0 = Switched OFF, 1 = Switched ON, 2 = state before power failure	0, 1, 2	2
UP 03	Celsius or Fahrenheit, Select ON for Fahrenheit, OFF for Celsius	ON, OFF	OFF (Celsius)
UP 04	Select contents of small digits in standard mode: 00 = OFF 01 = Setpoint 02 = Humidity Sensor 03 = External Temperature Sensor	0...3	01 Standard: show setpoint

### Control Parameters (Password 0241)

NOTE: Only experts should change these settings! See user parameters for login procedure.

**Table 2: Output Configuration**

Parameter	Description	Range	Default
CP 00	Minimum setpoint limit in humidification mode	0...100%	10%
CP 01	Maximum setpoint limit in humidification mode	0...100%	90%
CP 02	Start delay for fan (Time the fan runs before control output starts)	0...255 s	10 s
CP 03	Stop delay for fan (Time the fan keeps running after control output stops)	0...255 s	90 s

**Table 3: Temperature Setback Configuration - \*For humidity control only.**

Parameter	Description	Range	Default
CP 04	Enable temperature setback OFF = Temperature setback is disabled ON = Temperature setback is enabled	ON, OFF	OFF
CP 05	Setpoint limit at full setback	0...100%	20%
CP 06	Lower temperature limit: Outside temperature with maximum setback The setpoint will be equal to the minimum setpoint limit	-40...60 °C -40...160 °F	-30 °C (-22 °F)
CP 07	Upper temperature limit: Outside temperature at begin of setback.	-40...60 °C 40...160 °F	0 °C (32 °F)
CP 08	Number of seconds taken into account to calculate the averaging input signal. Low value = fast response High value = slow response	0...100	30

--	--	--	--

**Table 4: Technical Specification**

Power Supply	Operating Voltage	24 V AC/DC $\pm$ 10 %, 50...60 Hz
	Power Consumption	Max. 1.5 VA
	Electrical Connection	Terminal Connectors, wire: AWG 24...12
	Internal rectification: Signal ground = power ground	Half wave rectified Isolation transformer required
Signal Inputs	Humidity Input: Range Accuracy	Element: Polymer-Based Capacity Sensor 0...100% r.H. 10%...90% r.H. $\pm$ 5.0% 0...10% and 90...100% $\pm$ 7.0%
	Hysteresis	$\pm$ 1% r.H.
	Temperature Input Range Accuracy	External NTC (P/N: 2520263) -40...70 °C (-40...158 °F) -40...0 °C (-40...32 °F): 0.5 C 0...50 °C (32...122 °F): 0.2 C 50...70 °C (122...158 °F): 0.5 C
Signal Outputs	Digital Switching Outputs Switching type AC Switching power	D01...D02 Relays 2 x 1.0 A, 24 Vac max.
Environment	Operation Climatic Conditions Temperature Humidity	To IEC 721-3-3 class 3 K5 0...50 °C (32...122 °F) <95 % r.H. non-condensing
	Transport & Storage Climatic Conditions Temperature Humidity Mechanical Conditions	To IEC 721-3-2 and IEC 721-3-1 class 3 K3 and class 1 K3 -25...70 °C (-13...158 °F) <95 % r.H. non-condensing class 2M2
Standards	Product standards Automatic electrical controls for household and similar use	EN 60 730 -1 EN 60 730 - 2 - 9
	Degree of Protection	IP30 to EN 60 529
	Safety Class	III (IEC 60536)
Housing	Cover, back part Mounting Plate	Polycarbonate PC (UL94 class V-0) PTFE coated 1 $\mu$ m pores
General	Dimensions (H x W x D): Front part: Power case:	112 x 73 x 15 mm (4.4" x 2.9" x 0.6") $\varnothing$ 58 x 32 mm ( $\varnothing$ 2.3" x 1.3")
	Weight (including package)	220g

**Power Failure**

Upon power-interruption, all parameters and setpoints are memorized in non-volatile memory and therefore do not have to be re-entered again.

**Table 5: Error messages and Troubleshooting Guide**

Display	Cause	Symptoms	Corrective Action
Err1	Humidity sensor faulty. The humidity sensor is damaged.	The LCD screen will report the message Err1.	Check that the humidity sensing element is not loose
Err2	External input for temperature setback missing or damaged.	The LCD screen will report the message Err2.	Check that the temperature sensor is connected to the humidistat. If the sensor is connected and the error message persists a replacement sensor should be ordered.

**NOTE:** If at any time this troubleshooting guide fails to provide the information needed Nortec's Technical Support Department can be reached at 1-866-NORTEC-1 to provide assistance.

## NORTEC Wall and Duct ON/OFF HUMIDISTAT WIRING DIAGRAM

Use for NH-EL, RH Series, NHRS, GSTC/GSP, SETC/SEP, MHTC, AIRFOG, and HP with:

Part #	Description
2548731	Digital ON/OFF Wall Humidistat
2548732	Digital ON/OFF Duct Humidistat
2520263	Outdoor Temperature Sensor
2553858	Outdoor Mount Temperature Sensor

Warning: Failure to wire the humidity transducer in accordance with wiring diagram could permanently damage the electronics. Such errors will void the warranty.  
Cabling between transducers and unit should be shielded 18 AWG

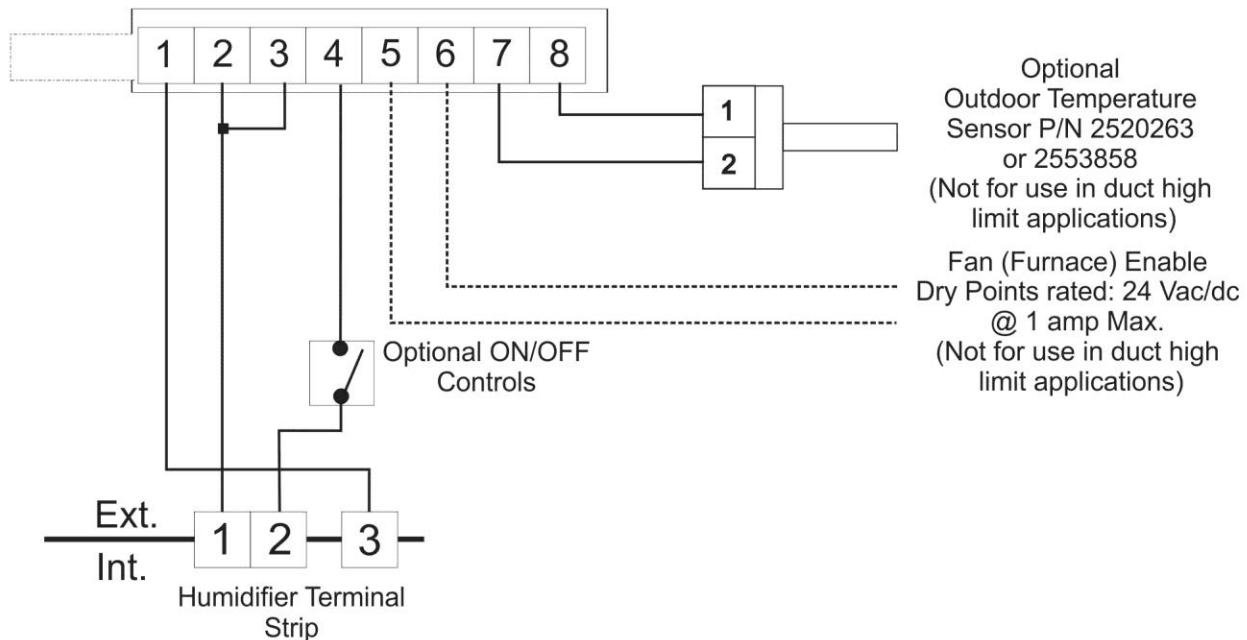

Humidistat - Relay Timing Chart

